

Sento soffitto due Niedervolt-Halogen

Deckenleuchte aus modularem Kopf-Körper-System

Das Occhio Kopf-Körper-System sorgt dank einzigartiger Modularität für beeindruckende Lichtlösungen im Raum. Für spezifische Lichtwirkungen stehen verschiedene, drehbare Reflektorköpfe zur Verfügung, die durch einen einfachen Steckmechanismus jederzeit leicht ausgetauscht werden können. Für die Montage stehen verschiedene Ein- und Aufbaudosen bzw. Gehäuse zur Auswahl.

Deckenleuchte Occhio Sento soffitto due besteht aus

- body Occhio soffitto due - verschiedene Längen und Oberflächen
- head Occhio Sento - versch. Lichtwirkungen und Oberflächen
- Occhio Zubehör - versch. Montagevarianten und Oberflächen

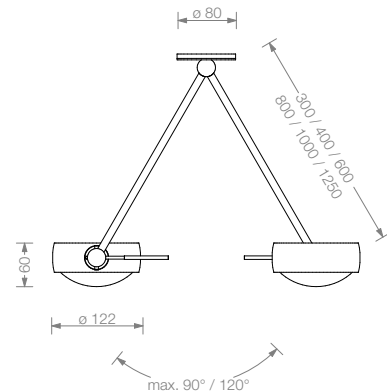
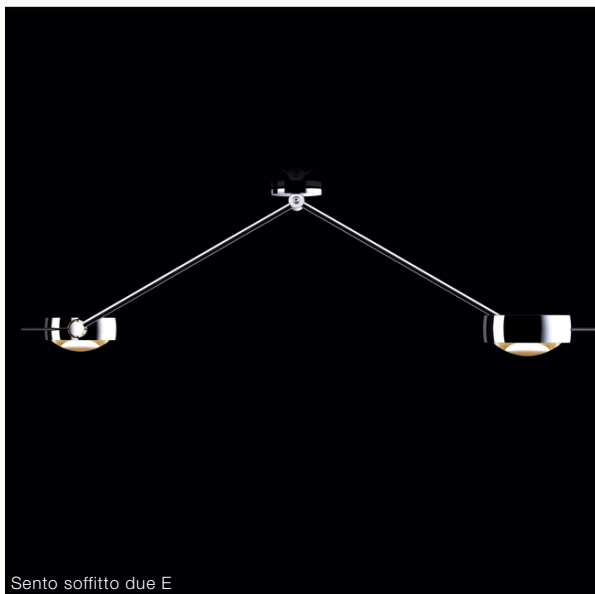

Material
Aluminium, Messing, Stahl, Glas

Oberfläche
Kopf: siehe S.2 Datenblatt
Körper: chrom, chrom matt

Länge / Schwenkbereich
30 cm, 40 cm, 60 cm / 120°
80 cm, 100 cm, 125 cm / 90°

empfohlene Lichtwirkung
B, C, E siehe S.2 Datenblatt

Leuchtmittel
Niedervolt-Halogen, Betriebsspannung 12 V
max. 2 x 60 W IRC, GY6.35,
Energieeffizienzklasse B, Lebensdauer 4.000 h

Lichtstrom (LM)
35 W / 860 lm, 50 W / 1180 lm, 60 W / 1650 lm

Farbtemperatur / Farbwiedergabe
3000 K / CRI 100

Gewicht
Reflektorkopf und Körper max. 3,5 kg

Montagezubehör
für Einbau oder Aufbau, siehe S.3 Datenblatt

Sento soffitto due empfohlene Lichtwirkungen

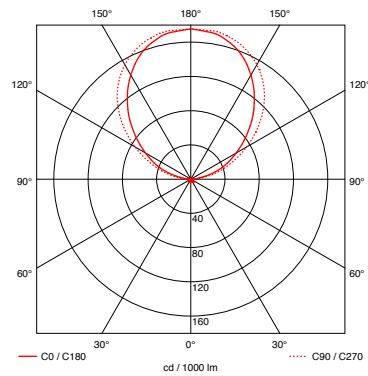
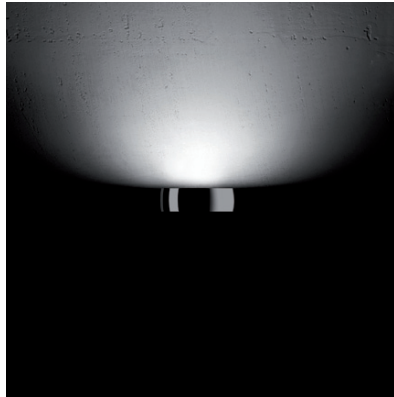

Sento B (satinieretes Glas / Cover)
Reflektorkopf für diffuses Licht
in eine Richtung

Leuchtenwirkungsgrad

49%

Glas

satinieretes, hitzefestes Glas

Ring / Cover

chrom, chrom matt

weiß oder schwarz glänzend lackiert
(bianco, nero)

Halter

chrom oder chrom matt

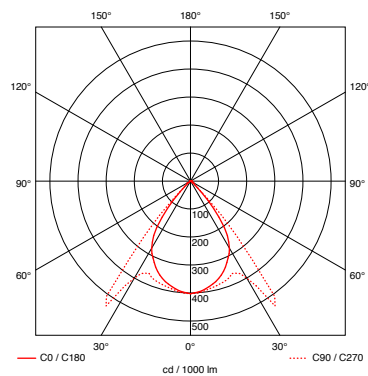

Sento C (Cover / Linse)

Reflektorkopf für gerichtetes Licht
in eine Richtung

Leuchtenwirkungsgrad

56%

Lichtkegel

ca. 85°

Linse

optisches Glas

Ring / Cover

chrom, chrom matt,

weiß oder schwarz glänzend lackiert
(bianco, nero)

Halter

chrom oder chrom matt

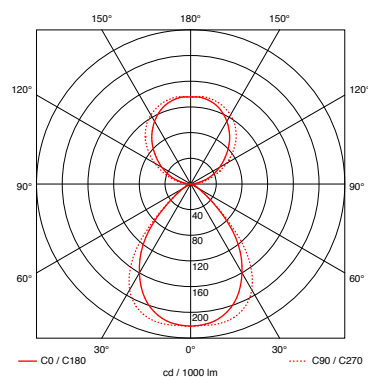

Sento E (satinieretes Glas / Linse)

Reflektorkopf für diffuses Licht in eine und
gerichtetes Licht in die andere Richtung

Leuchtenwirkungsgrad

82%

Lichtkegel

ca. 85°

Glas

satinieretes, hitzefestes Glas

Linse

optisches Glas

Ring

chrom, chrom matt,

weiß oder schwarz glänzend lackiert
(bianco, nero)

Halter

chrom oder chrom matt

Datenblatt

Occhio

3 | 4

Sento soffitto due Artikelnummern

Artikelnummer
_chrom matt M
_chrom C

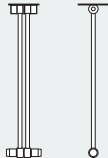
<p>soffitto due</p> 	<p>max. 2 x 60 W Niedervolt-Halogen, GY6.35</p>	<table border="1"> <tr> <td>30 cm</td> <td>7S 32 00 _</td> </tr> <tr> <td>40 cm</td> <td>7S 33 00 _</td> </tr> <tr> <td>60 cm</td> <td>7S 34 00 _</td> </tr> <tr> <td>80 cm</td> <td>7S 35 00 _</td> </tr> <tr> <td>100 cm</td> <td>7S 36 00 _</td> </tr> <tr> <td>125 cm</td> <td>7S 37 00 _</td> </tr> </table>	30 cm	7S 32 00 _	40 cm	7S 33 00 _	60 cm	7S 34 00 _	80 cm	7S 35 00 _	100 cm	7S 36 00 _	125 cm	7S 37 00 _
30 cm	7S 32 00 _													
40 cm	7S 33 00 _													
60 cm	7S 34 00 _													
80 cm	7S 35 00 _													
100 cm	7S 36 00 _													
125 cm	7S 37 00 _													



<p>Sento B</p> 	<p>satiniertes Glas / Cover</p>	<table border="1"> <tr> <td>chrom matt</td> <td>8K 00 72 M</td> </tr> <tr> <td>chrom</td> <td>8K 00 72 C</td> </tr> <tr> <td>bianco</td> <td>8K 00 72 B</td> </tr> <tr> <td>nero</td> <td>8K 00 72 N</td> </tr> </table>	chrom matt	8K 00 72 M	chrom	8K 00 72 C	bianco	8K 00 72 B	nero	8K 00 72 N
chrom matt	8K 00 72 M									
chrom	8K 00 72 C									
bianco	8K 00 72 B									
nero	8K 00 72 N									
<p>Sento C</p> 	<p>Cover / Linse</p>	<table border="1"> <tr> <td>chrom matt</td> <td>7K 00 63 M</td> </tr> <tr> <td>chrom</td> <td>7K 00 63 C</td> </tr> <tr> <td>bianco</td> <td>7K 00 63 B</td> </tr> <tr> <td>nero</td> <td>7K 00 63 N</td> </tr> </table>	chrom matt	7K 00 63 M	chrom	7K 00 63 C	bianco	7K 00 63 B	nero	7K 00 63 N
chrom matt	7K 00 63 M									
chrom	7K 00 63 C									
bianco	7K 00 63 B									
nero	7K 00 63 N									
<p>Sento E</p> 	<p>satiniertes Glas / Linse</p>	<table border="1"> <tr> <td>chrom matt</td> <td>7K 00 75 M</td> </tr> <tr> <td>chrom</td> <td>7K 00 75 C</td> </tr> <tr> <td>bianco</td> <td>7K 00 75 B</td> </tr> <tr> <td>nero</td> <td>7K 00 75 N</td> </tr> </table>	chrom matt	7K 00 75 M	chrom	7K 00 75 C	bianco	7K 00 75 B	nero	7K 00 75 N
chrom matt	7K 00 75 M									
chrom	7K 00 75 C									
bianco	7K 00 75 B									
nero	7K 00 75 N									

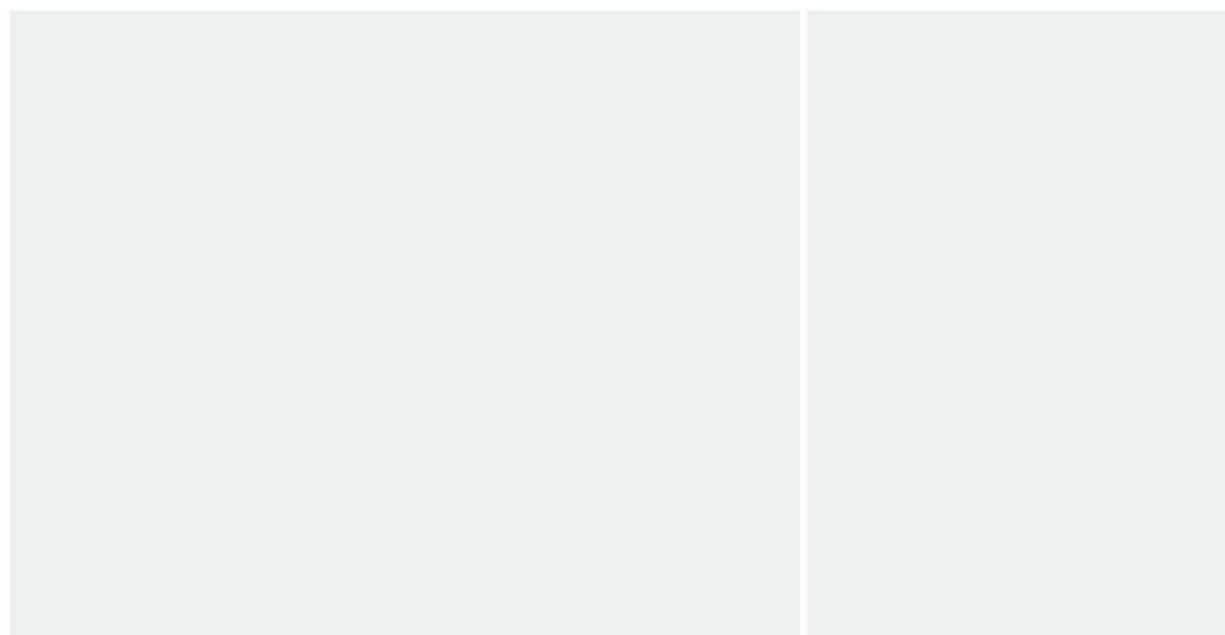

Sento soffitto due Artikelnummern

Artikelnummer
_chrom matt M
_chrom C



Einbau Transformator bauseits

Dose flach



für Hohlraumdose und bauseitige
Wand- / Deckendose, h 8 mm, ø 80 mm

8Z 00 00 M
8Z 00 00 C

elektr. Transformator max. 150 W

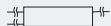

für Montage in Hohlwand / -decke,
phasenan- / abschnittdimmbar,
50 – 150 W,
l 153 mm, b 54 mm, h 36 mm

7Z 00 03 T

elektr. Transformator max. 105 W



für Montage in Hohlwand / -decke,
phasenan- / abschnittdimmbar,
35 – 105 W,
l 107 mm, b 52 mm, h 30 mm

7Z 00 01 T

elektr. Transformator max. 70 W



für Montage in Unterputzdose (Wand / Decke),
nicht für vertikale an
der Decke, nicht für Hohlraumdose,
phasenan- / abschnittdimmbar, 20 – 70 W,
ø 53 mm, h 22 mm

7Z 00 02 T



Transformator in Aufbaugehäuse

Gehäuse due

mit 2 soffitto singolo
Körper soffitto singolo siehe
Datenblatt Deckenleuchte soffitto singolo



Aufbauversion für
2 x soffitto singolo NV
inkl. 2 x elektronischem
Transformator 35 – 75 W
l 304 mm, b 88 mm, h 36 mm

track Version

matt chrom 7Z 90 2 00 M F
chrom 7Z 90 2 00 C F
bianco / chrom 7Z 90 2 00 B F
nero / chrom 7Z 90 2 00 N F

matt chrom 4Z 90 2 00 M F
chrom 4Z 90 2 00 C F
bianco / chrom 4Z 90 2 00 B F
nero / chrom 4Z 90 2 00 N F